

Little effort, big effect:



**Guidebook
& checklist**

**Ergonomics and efficiency
at manual workstations**



- 15 WD

ERGONOMICS IS WORTH THE EFFORT

A grab distance which is 20 cm shorter could save 15 working days per year!

See MTM example calculation on page 12

22.4 %

Almost a quarter of all absences are due to muscular and skeletal problems!

Absence Report 2020, Springer-Verlag

- €0.5 million

A 5 percent reduction in absences could save half a million euros!

Automotive supplier with 2,000 employees and on average 11.2 sick days per year (Source: Federal Statistical Office, Institute for Employment Research, 2021) at a cost of €410 per sick day (Source: Federal Institute for Occupational Safety and Health, 2018)



Ergonomics – the ideal basis for lean production and connected industry

The merging of production and corporate IT and the synchronization of processes that are as lean as possible with machines that make decisions autonomously in real time – all this is important today for efficient, customer-specific production. But value chains will only improve across the board with the integration of ergonomically designed work systems that enable people to work without wasting resources.

On the following pages, we would like to show you the enormous potential that lies dormant here. Good ergonomics not only saves a lot of time, money and hassle – ergonomics increases employee motivation, reduces absences and makes your value chain much more efficient.

Put together a production system which takes into account lean production, connectivity and ergonomics equally. Bosch Rexroth provides the solutions to do this.

WE MOVE. YOU WIN.

Ergonomics – for greater motivation, higher productivity and better quality

Make work easier for people and protect their health

The benefits of ergonomically designed workplaces for workers have been proven in many studies and the results speak for themselves: Increased motivation and satisfaction, better performance, efficiency and work quality and fewer absences owing to illness. The bottom line: A big improvement in productivity, increased efficiency and a decisive edge over the competition – thus ensuring lasting success for your company.



4 KEY TOPICS:

BODY. MOVEMENT. VISION. PLANNING.

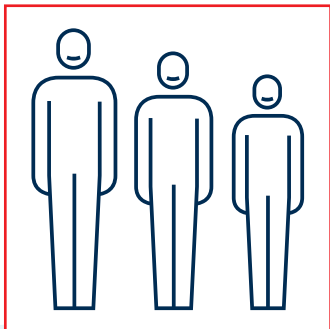

Body height and working height

The optimum working height depends on the worker's body height and the type of activity to be performed. The average optimum working height for moderate requirements is 1,125 mm for sit-down/stand-up workstations.

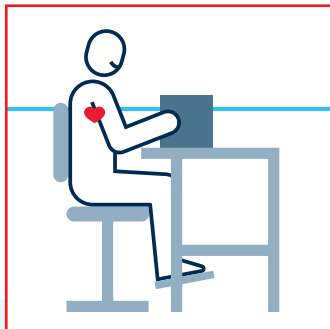

Work area

The work area should always be between 800 mm and 1,500 mm high. Working positions above heart height should be avoided, as should any work below 800 mm, as bending places an undue strain on the worker's body. Ideally, workers should perform dynamic activities with frequent shifts of posture, such as switching between standing and sitting.

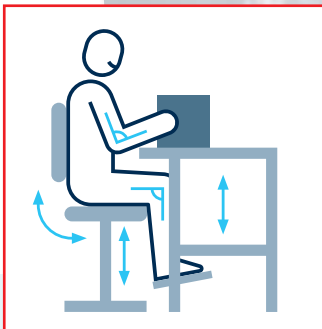

Adjustment of work equipment

Correct adjustment of work equipment helps to minimize required movements, thus reducing physical exertion and employee absences.



Grab area, parts supply and freedom of movement

All containers, equipment and operating elements should be easily accessible and located in the anatomical/physiological range of movement for the employee. Torso rotations and shoulder movements, particularly when under exertion, should be avoided whenever possible.

From page 6

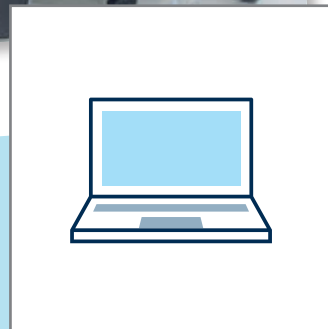
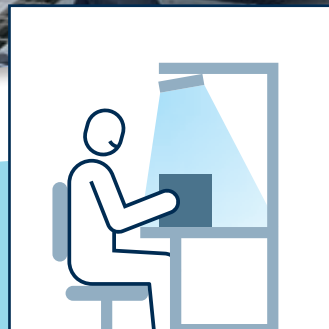
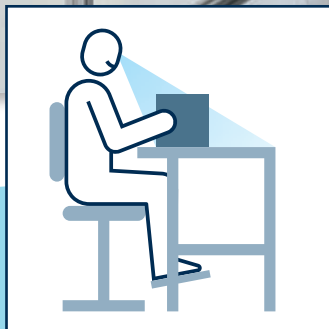
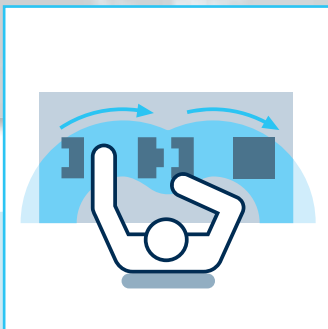

Vision areas

Unnecessary head and eye movements should be avoided. Maintaining objects at a uniform distance to the worker's eyes eliminates the need for refocusing. Avoid joining points that are not visible to the worker.

Lighting

Ideal lighting conditions prevent early onset fatigue, improve concentration and reduce the risk of errors. High contrasts, glare and reflections should be avoided.

Planning aids

Ergonomic workplace design starts with planning. The MTpro software is particularly useful here.

From page 10

From page 14

Page 16

Body height and working height

BODY HEIGHT

Manual workplace systems should accommodate a wide range of body heights to ensure that the largest percentage of the population possible is covered. Country-specific differences and regional requirements should also be taken into account. In Germany, for example, DIN EN ISO 14738 applies when specifying and designing a workstation. The most important factors when designing work equipment are the working height, the sizing of grab areas and leg room and defining an appropriate range of vision. All of these measurements are derived from a “standardized” body height.

Classification of body heights

The body heights of the population can be classified into four groups:

- ▶ Group 1: Smallest woman (only 5% are smaller)
- ▶ Group 2: Average woman and smallest man
- ▶ Group 3: Largest woman and average man
- ▶ Group 4: Largest man (only 5% are larger)

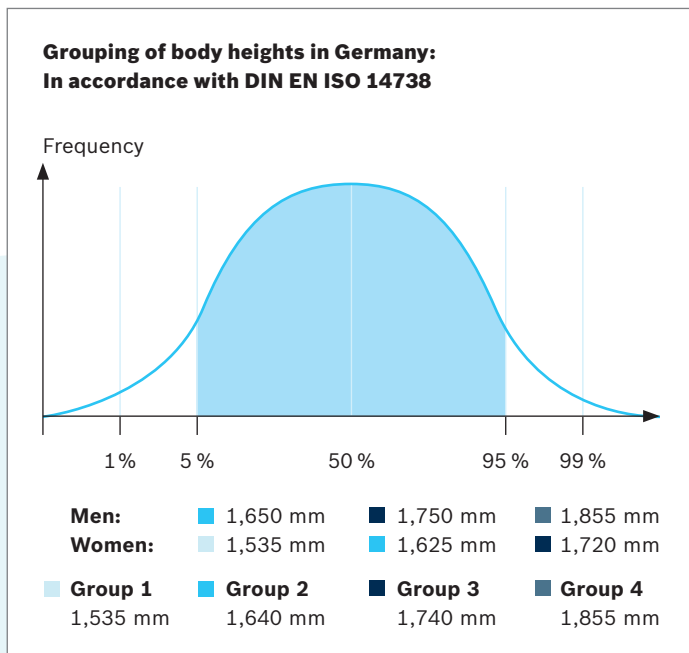

WORKING HEIGHT

Determining the optimum working height

The optimum working height is based on the body height range and the type of activity to be performed (see table). If all body heights are taken into consideration, the average optimum working height for moderate requirements is 1,125 mm for sit-down/stand-up workstations.

Requirements	Working heights (mm)			
	1	2	3	4
High requirements				
Visual inspection	1,100	1,200	1,250	1,350
Fine motor skills				
Medium requirements				
Visual inspection	1,000	1,100	1,150	1,250
Fine motor skills				
Low requirements				
Visual inspection	900	1,000	1,050	1,150
Elbow room				
Optimum working height		Ø = 1,125		

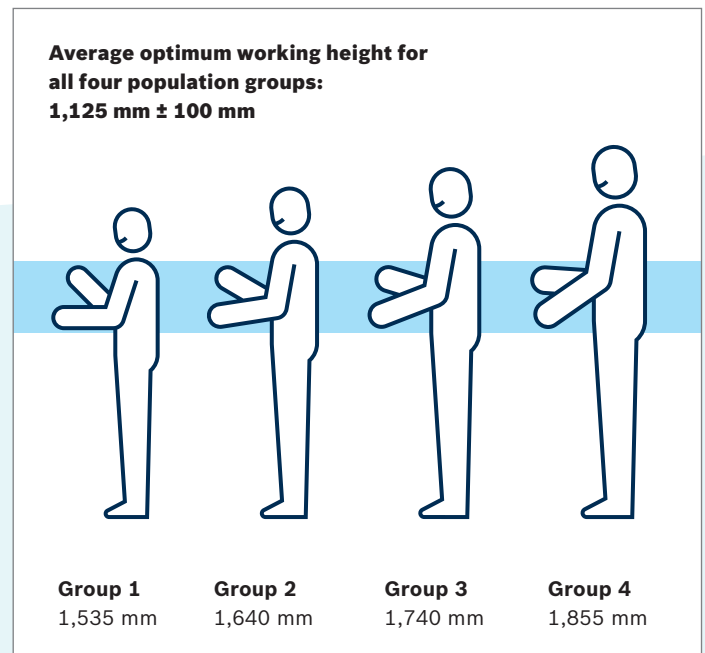

Determining the table height

The table height is based on the optimum working height minus the height of the workpiece or insertion height. To ensure sufficient leg room for those in body height group 4 as well, we recommend a minimum height of 1,000 mm for sit-down and stand-up workstations. Other criteria that need to be taken into account:

- ▶ Foot and leg room, depth and adjustment range of the footrest
- ▶ Size and variation of workpiece dimensions
- ▶ The forces and weights which occur
- ▶ Changing types of equipment and insertion heights
- ▶ Greatly varying vision distances
- ▶ Local requirements (deviating body heights, legal requirements etc.)
- ▶ Aspects related to methods, safety and efficiency

Bosch Rexroth's sit-down/stand-up concept

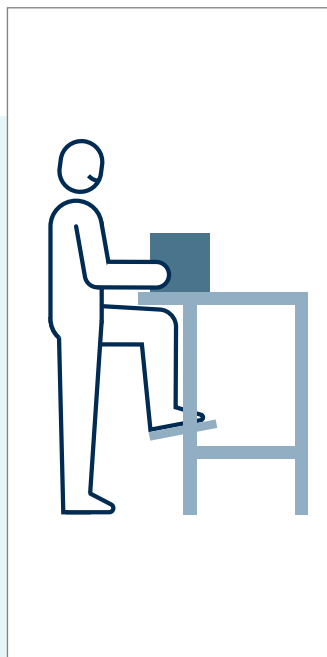

The sit-down/stand-up concept developed and recommended by Rexroth makes it possible to work at the same height when sitting and standing. This largely compensates for different body heights. The concept allows changes in posture, and thus reduces stress and improves performance. This is not possible with a sit-down or stand-up workstation alone.

Flow rack system design

The container weight and type of activity play a key role when designing flow rack systems. We recommend the arrangement shown in the figure. The following aspects should also be taken into account when supplying and removing materials:

- ▶ The employee's overall exertion during a shift
- ▶ Country-specific requirements and standards

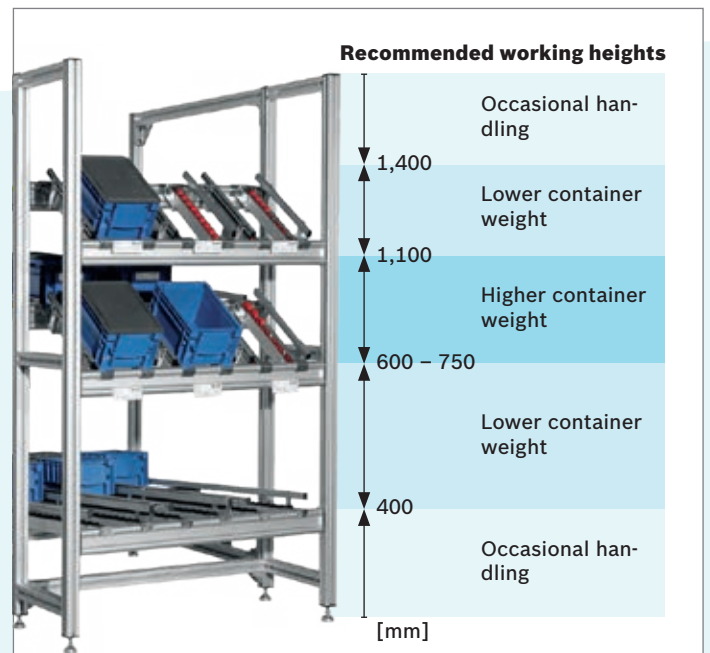

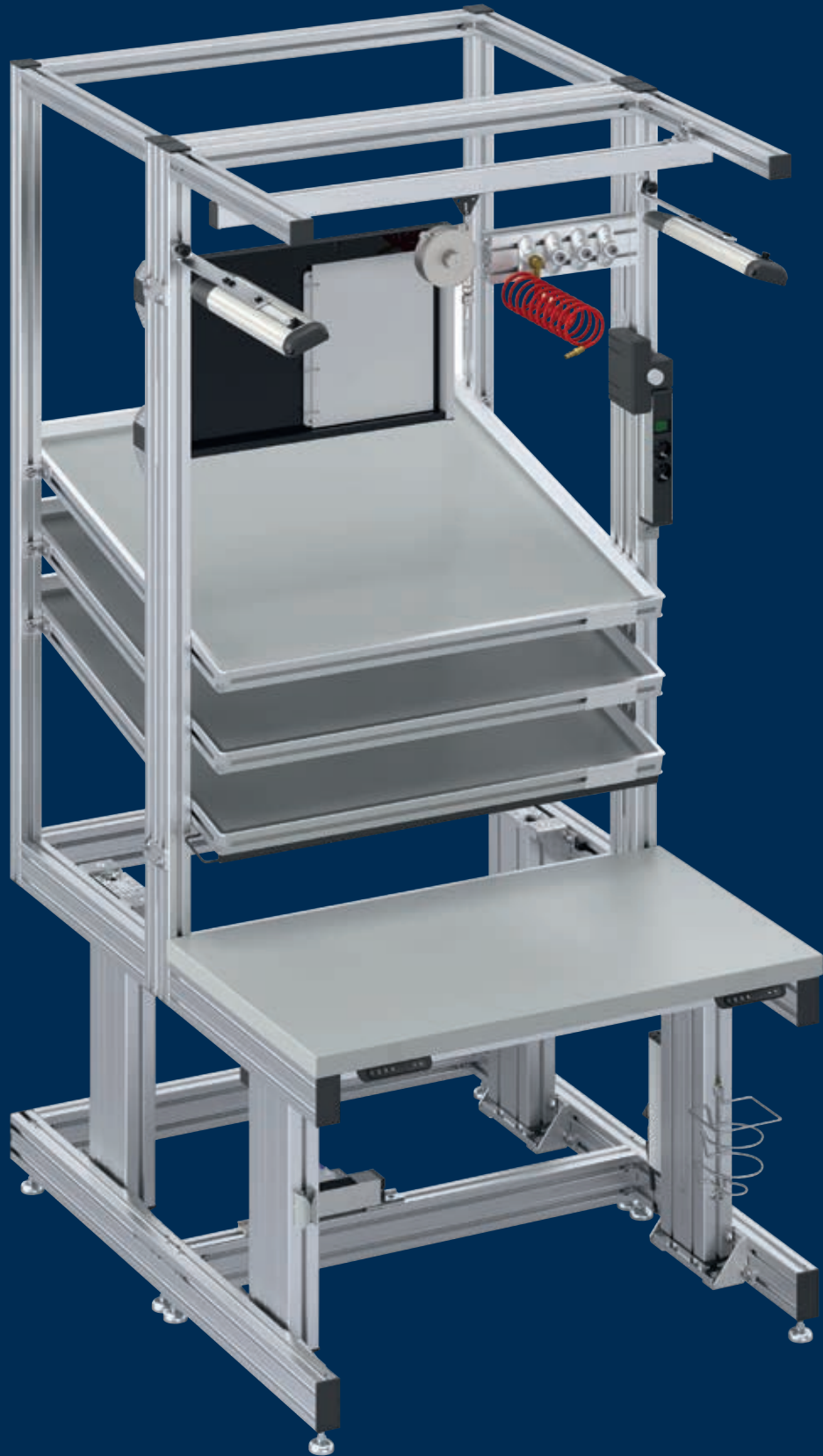

Electrically height-adjustable workstations ensure maximum flexibility when carrying out dynamic activities – with optimum freedom of movement

Adjustment of work equipment

To maintain performance and productivity, all work equipment near the workstation must be precisely adjusted to the employee and the activity. All of the Rexroth components for equipping workstations can be combined to form a perfectly coordinated ergonomic system. They offer numerous adjustment options that promote proper posture and reduce fatigue.

The correct posture when sitting is essential when it comes to improving performance and productivity: The worker's calves and thighs should form a 90° angle. This also applies to the upper and lower arms, though here the angle may be slightly greater than 90°. Correct adjustment of the table, chair, footrest and grab containers, as well as the position of tools and material shuttles help to minimize movements – thus reducing physical exertion and employee absences. Rexroth swivel work chairs feature an anti-tilt five-leg base. The legs have flat ends to reduce the risk of tripping.

Important information

- ▶ When adjusting the chair and footrest, the thighs and calves should form a right angle
- ▶ Information boards should be hung at eye level to avoid unnecessary head movements
- ▶ The angle of the shelves for material supply should be adjusted to ensure short, direct grab distances
- ▶ Lifting aids should be used when handling heavy parts
- ▶ Monitor brackets and tool shelves can be adjusted to any height via the profile slot
- ▶ With height-adjustable workstations, the optimum working height can be set according to the size of the person and product
- ▶ Information as to how to adjust the work equipment individually can be provided on information boards
- ▶ If processes, products or employees change frequently, the work equipment should be checked regularly to ensure proper ergonomic adjustment

Adjustment of material feed height and working height: Height-adjustable workstations can be adapted to both the product and the worker.

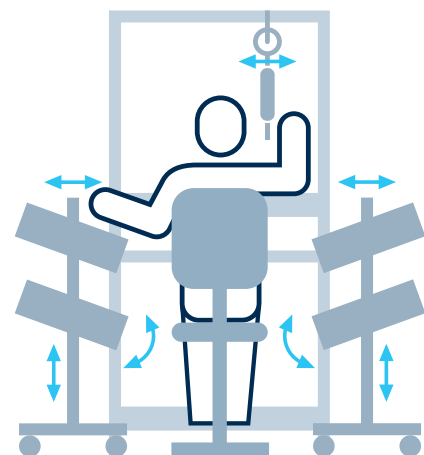
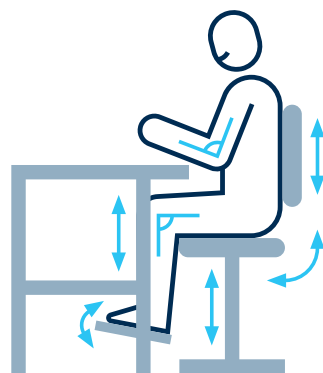

Movement and freedom of movement

THE WORK AREA

The necessary activities and the work procedure are determined on the basis of a set cycle time. The optimum working method is determined as part of a method analysis that takes time, ergonomics and efficiency into account. The aging work force and changing employee performance should also be borne in mind. In our experience, taking into account everyone involved in the process, for example from assembly, quality assurance and logistics, ensures the best results and long-term acceptance of the method and thus the workstation system.

The work area height should always be between 800 and 1,500 mm. The following rules should be observed:

- ▶ **Avoid work above heart level**
Otherwise, the blood circulation and thus the supply of oxygen to the muscles is reduced, which leads to a drop in performance. Work that requires bending (below 800 mm) taxes employees unnecessarily and should be avoided.
- ▶ **Encourage dynamic activities**
Static activity inhibits blood circulation and oxygen supply to the muscles. This can lead to a drop in performance and work quality
- ▶ **Allow for varying physical exertion**
For example through sit-down/stand-up workstations or job rotation. Varying physical exertion reduces stress on the employee and increases performance
- ▶ **Minimize exertion**
For example through the use of manual slide sections or lifting aids and by selecting more lightweight materials



A work area below the heart level ensures a good supply of oxygen to the muscles and increased performance





Resting

required supplied

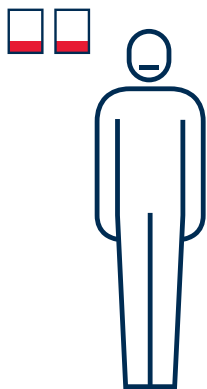

Static activities reduce the blood and oxygen supply

required supplied

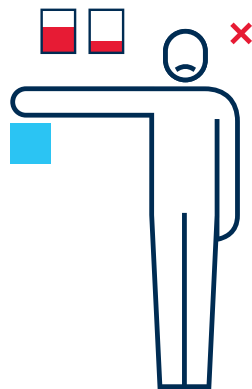

Dynamic activities ensure an adequate oxygen supply

required supplied

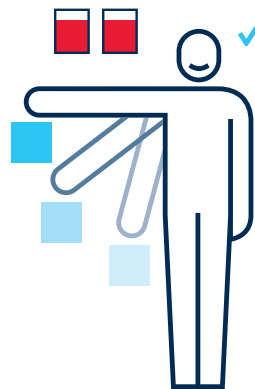

THE GRAB AREA

In the grab area, all tools and equipment should be easily accessible and arranged within the range of movement for the employee.

A distinction is therefore made between three separate areas within the grab area as a whole:

- ▶ Area A: This is the central work area. Activities involving fine motor skills (including those using both hands) are carried out here.
- ▶ Area B: Tools and parts which are often picked up with just one hand can be found in this area.
- ▶ Area C: This is only for occasional handling (e.g. of empty containers) as it can only be reached by moving the shoulders and torso.



Potential savings as a result of optimizing the grab distance:
Example calculation based on a real-life situation using the MTM method (Method of Time Measurement)
 (TMU = Time Measurement Unit, approx. 0.0006 min.)

Reach distance	40 cm	20 cm
Time required for 1 repetition	52.0 TMU	39.8 TMU
Time required for 4,000 repetitions	208,000 TMU	159,200 TMU
Time required	125 min	96 min
Time required with 250 WD per year	521 hr	400 hr
Difference	+121 hr	- 30 %

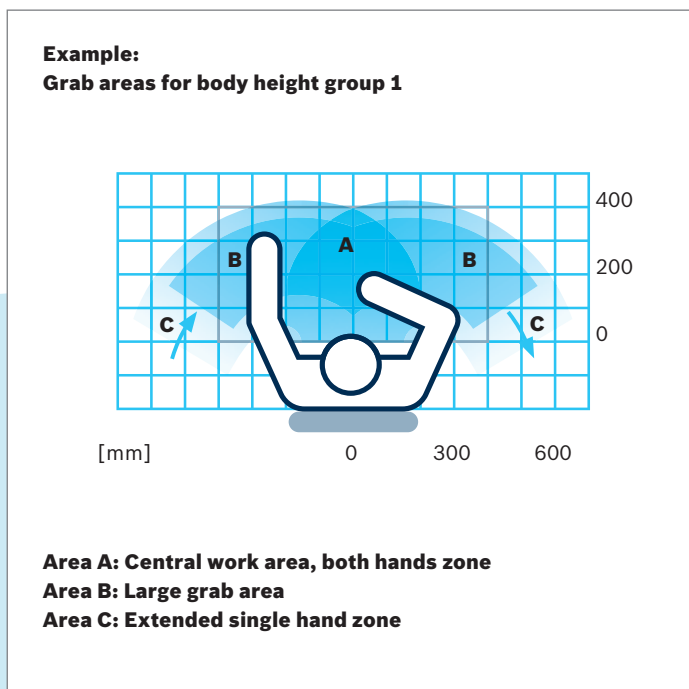

PARTS SUPPLY

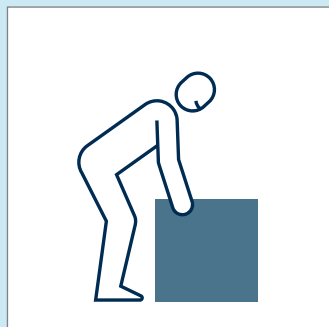
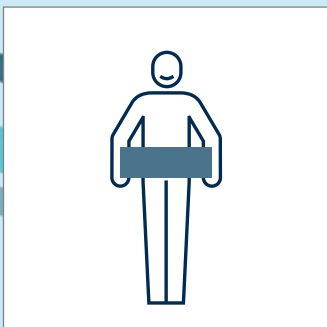
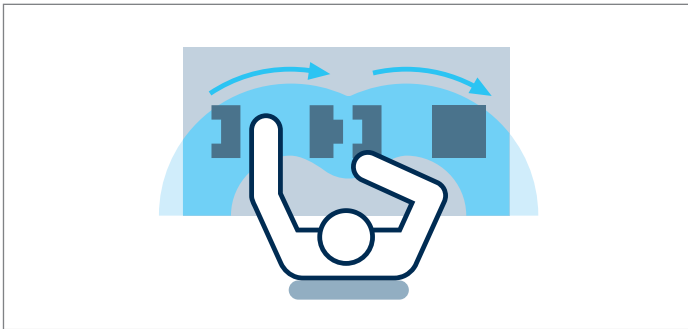

All reach distances should be as short as possible to avoid unnecessary movements that create no additional value and thus wastage. Grab containers and parts containers placed within reach of the employee are ideal. The position of these containers should allow a flowing movement that curves upwards away from the body when parts are removed.

Important information:

- ▶ Positioning of all grab containers in Areas A and B
- ▶ The more frequently a grab container is used, the shorter the reach distance should be
- ▶ Heavy parts should be stored within reach in the lower containers to avoid unnecessary exertion (e.g. caused by lifting and lowering)
- ▶ Bending of the torso below 800 mm places unnecessary strain on the human body
- ▶ Use of geometric and physical features of the parts during parts transfer, e.g. through the use of a slide rail or roller track
- ▶ Container sizes selected according to parts geometry, maximum weight and refill cycle
- ▶ On the basis of MTM, the time required for parts supply and removal can be reduced by up to 68%!

Limit values for lifting and carrying loads

Reasonable load (kg)	Occasionally (= less than 2 x/h with max. 2-3 steps under load)	Frequently (= more than 2-3 x/h)
----------------------	--	-------------------------------------

Age (years)	Women	Men	Women	Men
15 – 18	15	35	10	20
19 – 45	15	55	10	30
45 +	15	45	10	25



Vision and light

THE VISION AREAS

For optimum workstation design, it is important to follow the recommendations on proper ergonomics for vision as well.

A distinction is made between two vision areas:

- ▶ In the field of view (blue vision area), several objects can be seen in focus simultaneously without moving the eyes or head. Additional focusing for depth may be required here.
- ▶ In the visual field (light blue vision area), objects can be seen by moving the eyes, but not the head. Additional focusing for depth may be necessary here too.

Head movements are necessary to see objects outside these areas.

Important when planning assembly workstations and parts supply:

- ▶ Avoid unnecessary eye and head movements
- ▶ Implementing vision distances that are as identical as possible eliminates the need for refocusing
- ▶ Avoid joining points that are not visible to the worker

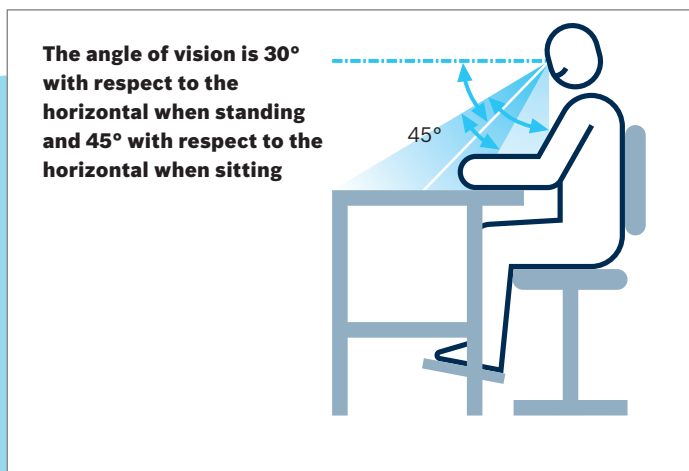
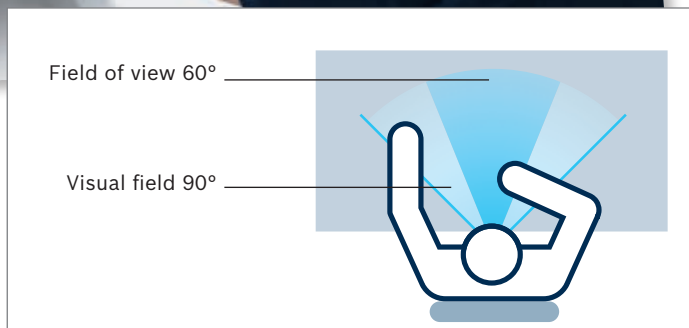

Observing these three recommendations makes work easier and increases productivity. After all, every time an employee turns their head, looks in a different direction or refocuses this wastes time and thus costs money. The exact figures can be determined using the MTM procedure.

LIGHTING

The right lighting, geared to the activity at the particular workstation, is a basic prerequisite for high efficiency and work quality. After all, ideal lighting conditions prevent early onset fatigue, improve concentration and reduce the risk of errors.

Important for workstation lighting:

- ▶ Avoid strong contrasts
- ▶ Avoid glare and reflection
- ▶ DIN EN 12 464 and the table below set out the required mid-range lighting intensities
- ▶ Lighting of test workstations that is free of shadows, flickering and glare

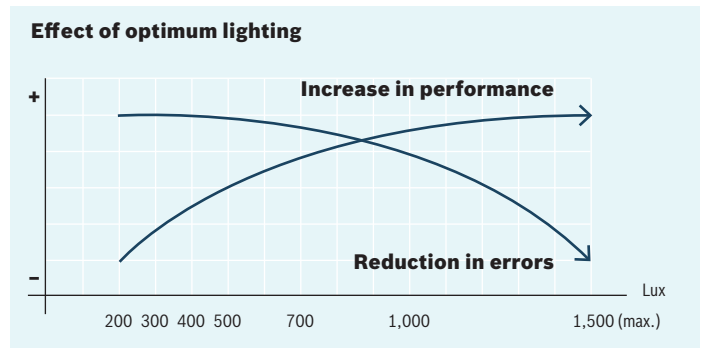

- System lamp sufficient for task
- System lamp + ambient light (300 lux) sufficient for task

The right LED system lamp for every task						
Example calculation for worktop lighting (* Distance from the table top to the lamp = 1.25 m) Rexroth SL 12 economic (rated illuminance) 700 Lux + ambient lighting 300 Lux = lighting on the worktop of 1000 Lux						
Tasks	Required illuminance (Lux)	SL 12 economic	SL 12 economic wide	SL 12 basic Duo	SL 24 basic	SL 24 basic + SL 12 basic Duo (Tri-Light)
Rough and medium machine and assembly tasks such as turning, milling and planing	300	*	*	*	*	*
Fine machine tasks with permissible deviations	500	*	*	*	*	*
Fine assembly tasks, e.g. telephones, winding medium-sized coils, marking, inspection and measuring stations	750	*	*	*	*	*
Very fine assembly, e.g. measuring instruments, assembly of tools, gages and equipment, precision mechanics and micromechanics	1,000	*		*	*	*
Assembly, inspection and adjustment of extremely small parts	1,500					*

Plan ergonomic assembly lines the quick, easy and reliable way – with MTpro

Careful and comprehensive planning is the only way to integrate ergonomics and lean production into the production system in a cost-effective manner.

Ergonomic workplace systems help to keep workers both healthy and productive. What is more, they create the foundation for implementing lean production concepts and for improving the economic efficiency of companies.

However, adapting production systems to ergonomic and lean production requirements later on is cost-intensive. And as product life cycles and unit production numbers continue to shrink, so does the time left for planning. This is where MTpro can provide valuable support. This planning software (available in a desktop version or in a flexible 24/7 online version) is designed with both needs in mind and offers good visualization as well as a CAD interface.

Users without CAD experience can use this software to design workstations, flow rack systems, manual linking

sections and material shuttles with a click of the mouse. The user-friendly system allows users to create their designs by either using a guided parameter selection system for configurable products or by putting together various discrete components. A comprehensive set of rules covers the design logic, all product dimensions and the necessary information on accessories.

ManModel – for optimum ergonomic designs

The "ManModel" is yet another ergonomic highlight. With this feature, MTpro can optimize designs for human use. Based on the dimensions of the human body, the ideal grab area, the proper distance from work equipment and the proper angle of vision can be easily visualized and the production systems then designed. Users can then retrieve complete parts and order lists, price calculations and CAD data.

- ▶ **MTpro ManModel makes it possible to integrate workstation ergonomics as early as the planning stage**

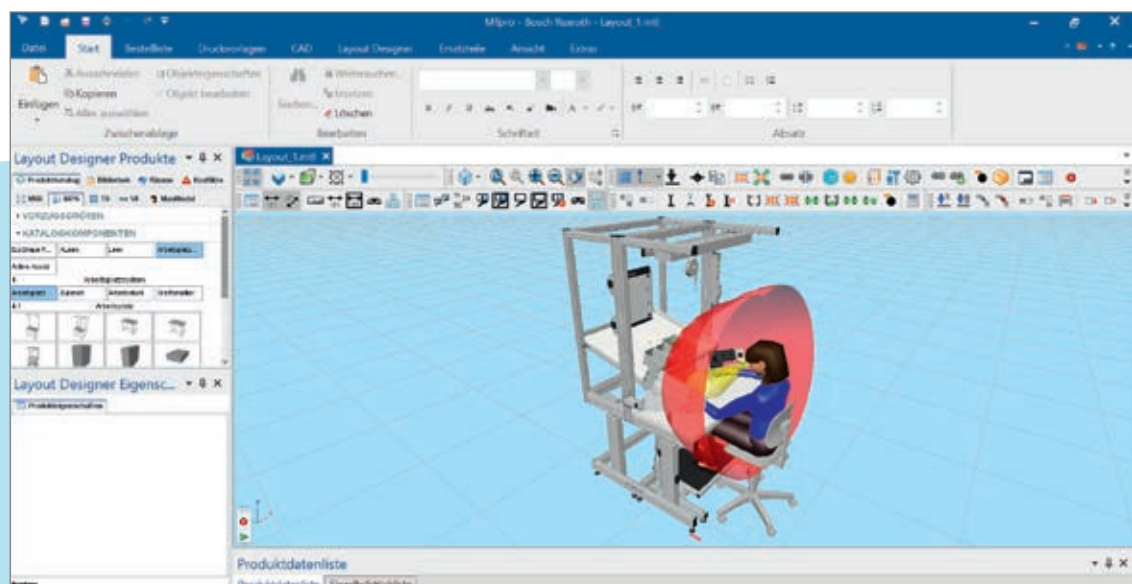

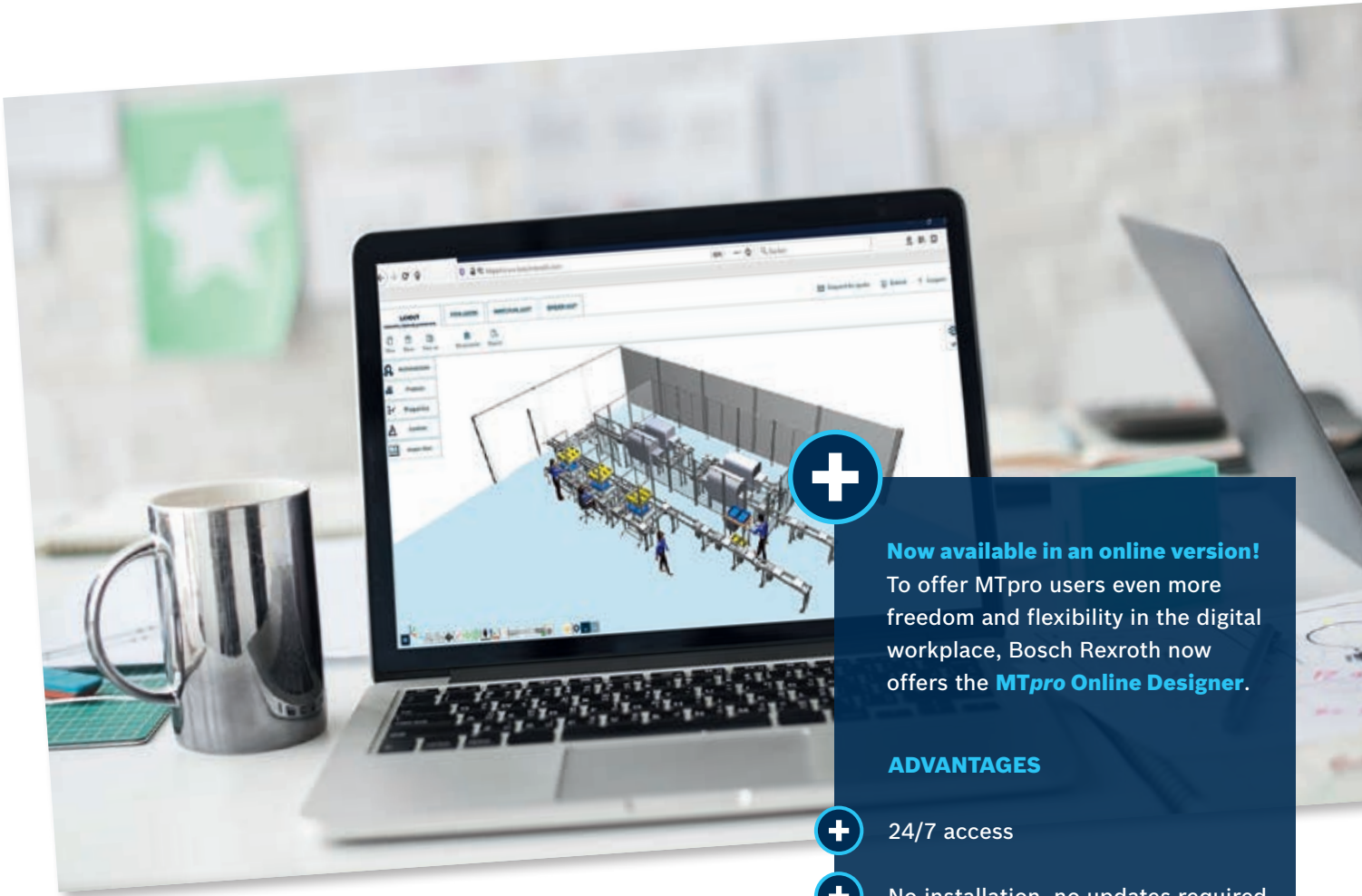

Now available in an online version!
 To offer MTpro users even more freedom and flexibility in the digital workplace, Bosch Rexroth now offers the **MTpro Online Designer**.

ADVANTAGES

- +** 24/7 access
- +** No installation, no updates required
- +** Share projects with other users
- +** Inquiries can be sent directly to Bosch Rexroth and certified partners
- +** Trouble-free exchange of layout files with the MTpro full version

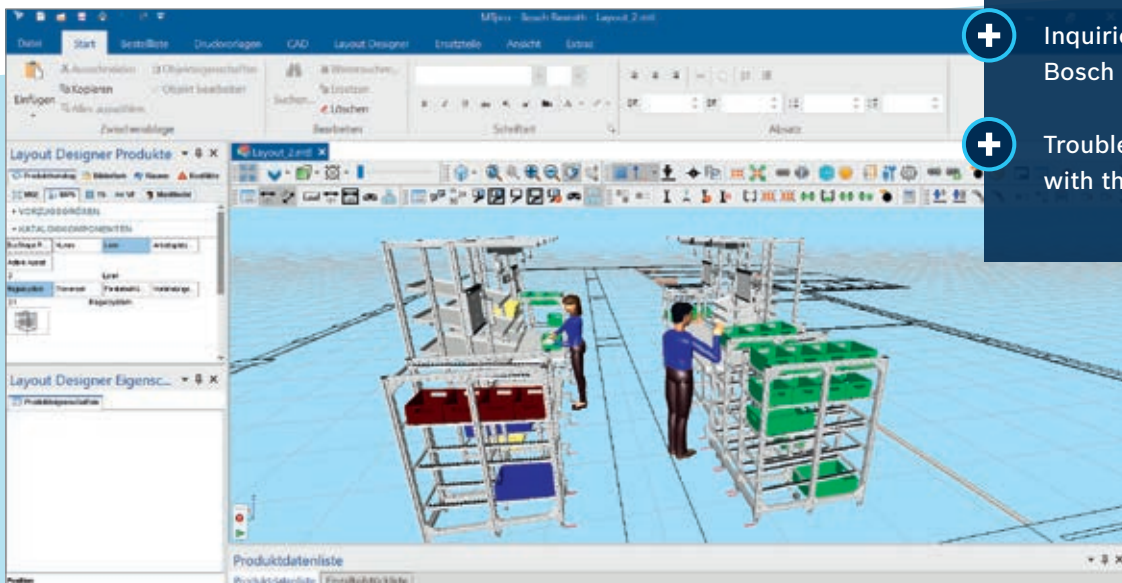

◀ **Multiple workstations are linked to form a production line that follows lean production principles**

14 questions – for your ergonomic workstations

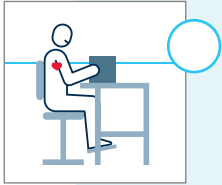

Can the employee work at an optimum height – below the heart line?



Does the employee have height-adjustable work equipment such as a chair or table?

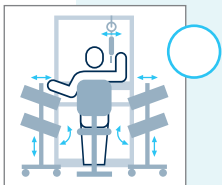

Can tools and measuring equipment, grab containers and material shelves which are used in cycles be reached easily?

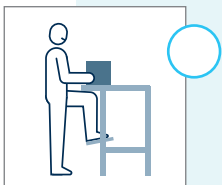

Can the employee work while sitting and standing?

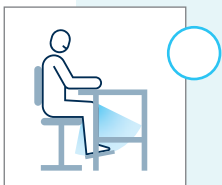

Does the workstation offer leg room and space for the employee's thighs? Does it have an adjustable footrest?

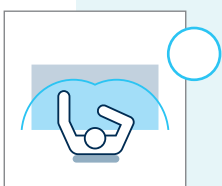

Are the grab distance and accessibility to working materials optimized for the particular employee?

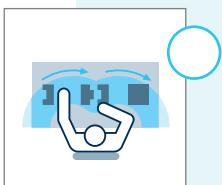

Is the insertion point which is used in cycles located within the working area?

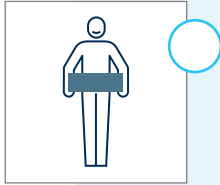

Do objects whose weight exceeds reasonable limit values need to be lifted or carried?

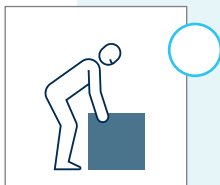

Does the employee need to bend frequently while working?

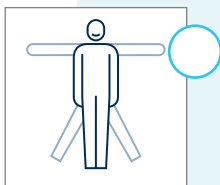

Does the worker have sufficient freedom of movement?

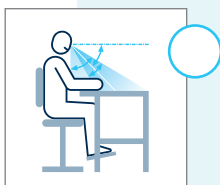

Is the work area fully visible?



Are the displays which need to be looked at frequently arranged centrally in the employee's field of vision?

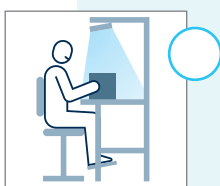

Is the lighting at the workstation sufficient to carry out work optimally? Is glare avoided?



Did you plan the workstation with the MTpro ManModel?

Improved ergonomics and greater efficiency with Rexroth products



▲ Workstations

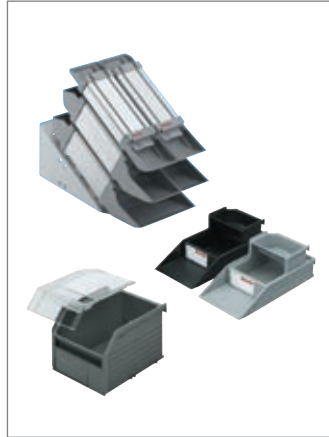

▲ Grab containers



▲ Swivel work chairs



▲ Flow rack systems



▲ EcoShape tubular framing system



▲ EcoFlow linking elements system



▲ Material shuttles
▲ FiFo station



▲ Case lifters



▲ Information boards



▲ ACTIVE Cockpit interactive software



▲ Self-assembly components

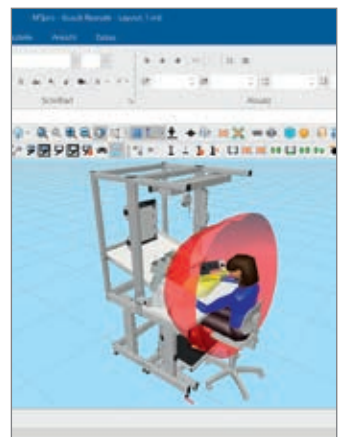

▲ MTpro planning software with ManModel

Bosch Rexroth AG

Postfach 30 02 07
70442 Stuttgart, Germany
www.boschrexroth.com

Further information online:



Find your local contact person here:
<https://addresses.boschrexroth.com/>

The data given above only serve to describe the product. Due to the continuing development of our products, no statements concerning a certain condition or suitability for a certain application can be derived from our information. The information given does not release the user from the obligation of own judgment and verification. It must be remembered that our products are subject to a natural process of wear and aging.

3 842 525 794 (2022-09)
© Bosch Rexroth AG 2022
Subject to change without notice!

